



INSERT 12





























CANALIZABLE

Opcionales:

Colores Disponibles

Wifi



-  Potencia Global Máx-Mín: 12,5 - 2,9 kW
-  Potencia Nominal Máx-Mín: 10,9 - 2,5 kW
-  Rendimiento Máx-Mín: 87,5 - 85,5 %
-  Volumen calefactable Máx-Mín: 220 m³
-  Consumo Horario Máx-Mín: 2,25 - 0,6 kg/h
-  Consumo Eléctrico Máx-Mín: 300 - 60 W
-  Peso: 98,6 Kg
-  Capacidad depósito: 15 Kg
-  Autonomía Máx-Mín: 25 - 7,8 H
-  Diametro aspiración de aire: 50mm
-  Diametro salida de humos: 80mm
-  Ventilación forzada (n°x m³): 1x400
-  Acceso fácil a mantenimiento
-  Control automático de regulación
-  Compatible con Kit WIFI
-  Encendido rapido
-  Interior de Vermiculita
-  Mando a distancia
-  Nuevo diseño de quemador
-  Programable
-  Quemador Hueso Compatible
-  Regulación Independiente de Motores
-  Silenciosa (1-10): 7
-  Sistema cristal limpio
-  Sistema doble Cámara
-  Sistema de modulación
-  Sistema Seguridad Sobrecarga Eléctrica
-  Sistema Seguridad Sobrepresión
-  Sistema Seguridad sobre Temperatura
-  Válvula sobrepresión cámara
-  Canalizable: 1x57
-  Salida Canalización Orientable

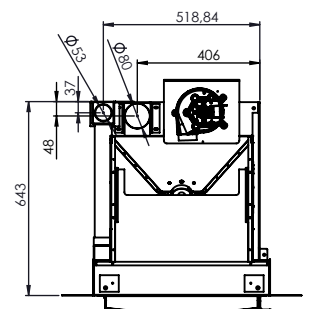
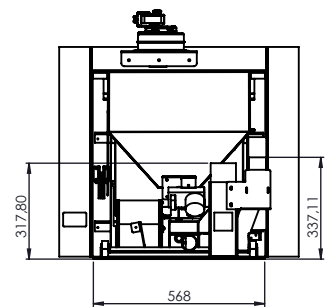
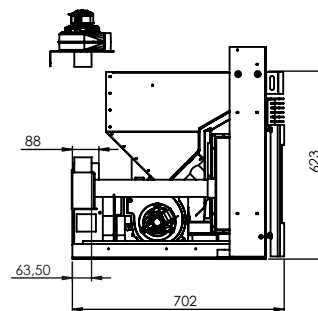
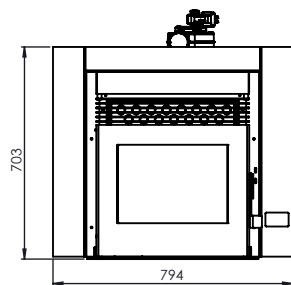
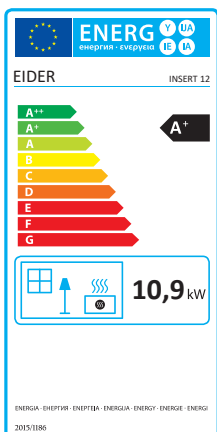

EIDER BIOMASA